

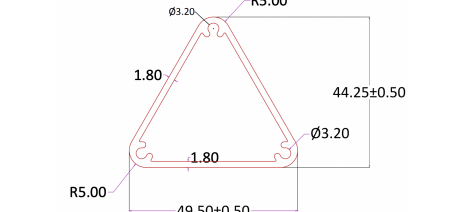

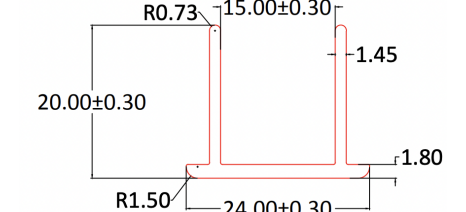

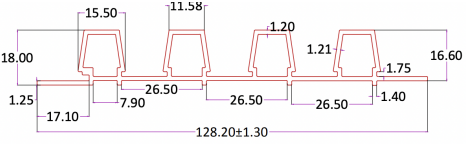

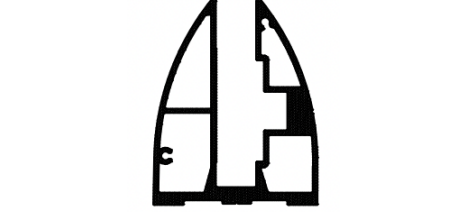

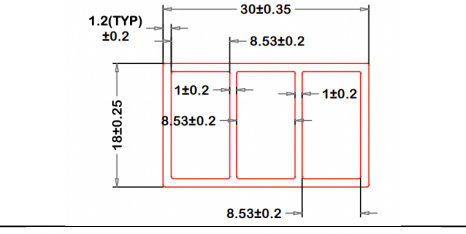
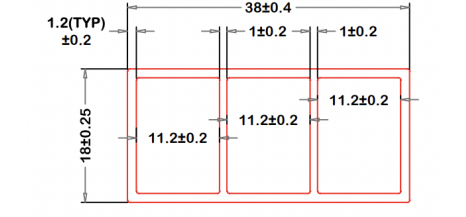
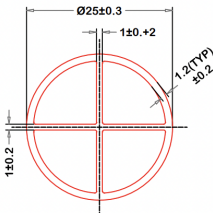

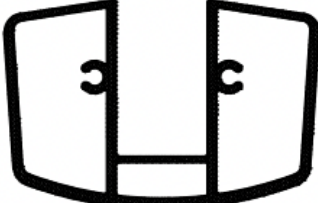
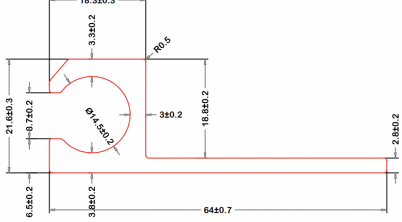
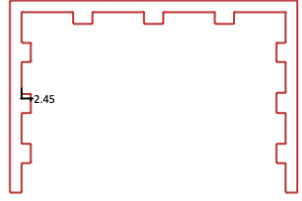
**STARS ALUMINIUM EXTRUSION PVT. LTD.**

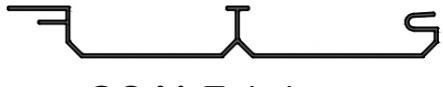
**GATE, GLASS AND ARCHITECTURE**

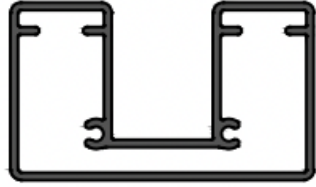
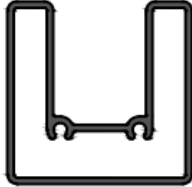
Serial Number	Section Number	Drawing	Weight Range (kg/12')
1	5654		6.1 - 6.4
2	5653		2.9 - 3.2
3	5656		0.9 - 1.2
4	5655		3.75 - 4.05
5	5658		8.6 - 8.9
6	5671		1.4 - 1.7
7	5670		1.6 - 1.9

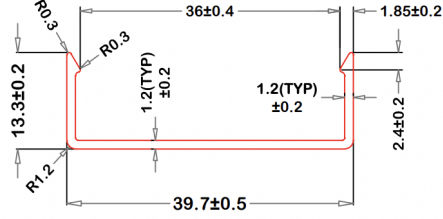
8	5669		1.3 - 1.6
9	5668		3.6 - 3.9
10	5667		5.4 - 5.7
11	5673		3.35 - 3.65
12	5652		6.2 - 6.5
13	5752		3.6 - 3.9
14	5762		5.6 - 5.9

15	5763		2.45 - 2.75
16	5761		2.8 - 3.1
17	5665		3.95 - 4.25
18	5664		2.95 - 3.25
19	5774		1.45 - 1.75
20	5773	 <p> <math>R0.3</math>  <math>36 \pm 0.4</math>  <math>1.85 \pm 0.2</math>  <math>13.3 \pm 0.2</math>  <math>R0.3</math>  <math>1.2(TYP) \pm 0.2</math>  <math>1.2(TYP) \pm 0.2</math>  <math>2.4 \pm 0.2</math>  <math>R1.2</math>  <math>39.7 \pm 0.5</math> </p>	0.75 - 1.05
21	5784		2.3 - 2.6

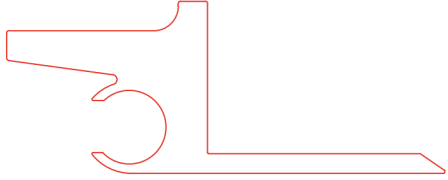
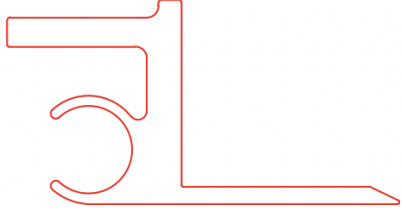
22	5378		4.35 - 4.65
23	5541		8.15 - 8.45
24	5564		5.3 - 5.6